



# OPERATOR'S M A N U A L

---

**OPEN FRYER (Gas)**

---

**MODEL**

**OFG-390**



**HENNY PENNY**  
Engineered to Last

REGISTER WARRANTY ONLINE AT [WWW.HENNYPENNY.COM](http://WWW.HENNYPENNY.COM)

Read instructions before operating the appliance



## NOTICE

This manual should be retained in a convenient location for future reference.

A wiring diagram for this appliance is located on the rear shroud cover of the control panel.

Post in a prominent location, instructions to be followed if user smells gas. This information should be obtained by consulting the local gas supplier.

Do not obstruct the flow of combustion and ventilation air. Adequate clearance must be left all around appliance for sufficient air to the combustion chamber.

The Model OFG- pressure fryer is equipped with a continuous pilot. But fryer cannot be operated with out electric power. Fryer will automatically return to normal operation when power is restored.

## CAUTION

*Keep appliance area free and clear from combustibles.*



**Improper installation, adjustment, alteration, service or maintenance can cause property damage, injury or death. Read the installation, operating and maintenance instructions thoroughly before installing or servicing this equipment.**



**DO NOT STORE OR USE GASOLINE OR OTHER FLAMMABLE VAPORS AND LIQUIDS IN THE VICINITY OF THIS OR ANY OTHER APPLIANCE. FIRE OR EXPLOSION COULD RESULT.**

**HENNY PENNY  
8 HEAD ELECTRIC PRESSURE FRYER**



*Fryer must be installed and used in such a way to prevent water from contacting the shortening.*



This appliance is not intended to be operated by means of an external timer or a separate remote control system.



This appliance is not intended for use by persons (including children) with reduced physical, sensory or mental capabilities, or lack of experience and knowledge, unless they have been given supervision or instruction concerning use of the appliance by a person responsible for their safety.

### Technical Data for CE Marked Products

Nominal Heat Input: (Net)	Natural ( $I_{2H}$ ) = 26,4 kW (90,000 Btu/h) Natural (I2E) = 26,4 kW (90,000 Btu/h) Natural (I2S) = 23,75 kW (81,000 Btu/h) Liquid Propane ( $I_{3p}$ ) = 27,0 kW (92,000 Btu/h)
Nominal Heat Input: (Gross)	Natural ( $I_{2H}$ ) = 29,3 kW (100,000 Btu/h) Natural (I2E) = 29,3 kW (100,000 Btu/h) Natural (I2S) = 26,4 kW (90,000 Btu/h) Liquid Propane ( $I_{3p}$ ) = 29,3 kW (100,000 Btu/h)
Supply Pressure:	Natural ( $I_{2H}$ ) = 20 mbar Natural (I2E) = 20 mbar Natural (I2S) = 25 mbar Liquid Propane ( $I_{3p}$ ) = 37/50 mbar
Test Point Pressure:	Natural ( $I_{2H}$ ) = 8,7 mbar Natural (I2E) = 8,7 mbar Natural (I2S) = 8,7 mbar Liquid Propane ( $I_{3p}$ ) = 25 mbar
Injector Size:	Natural ( $I_{2H}$ ) = 2,51 mm Natural (I2E) = 2.51 mm Natural (I2S) = 2.85 mm Liquid Propane ( $I_{3p}$ ) = 1,40 mm

This appliance must be installed in accordance with the manufacturer's instructions and the regulations in force and only used in a suitable ventilated location. Read the instructions fully before installing or using the appliance.

### Datos Tecnicos Para Products CE

Consumo Calorico Nominal: (Neto)	Gas Natural ( $I_{2H}$ ) = 26,4 kW (90,000 Btu/h) Gas Natural (I2E) = 26,4 kW (90,000 Btu/h) Gas Natural (I2S) = 23,75 kW (81,000 Btu/h) Propano Licuado ( $I_{3p}$ ) = 27,0 kW (92,000 Btu/h)
Consumo Calorico Nominal: (Bruto)	Gas Natural ( $I_{2H}$ ) = 29,3 kW (100,000 Btu/h) Gas Natural (I2E) = 29,3 kW (100,000 Btu/h) Gas Natural (I2S) = 26,4 kW (90,000 Btu/h) Propano Licuado ( $I_{3p}$ ) = 29,3 kW (100,000 Btu/h)
Presion De Alimentacion:	Gas Natural ( $I_{2H}$ ) = 20 mbar Gas Natural (I2E) = 20 mbar Gas Natural (I2S) = 25 mbar Propano Licuado ( $I_{3p}$ ) = 37/50 mbar
Presion En Ez Punto De Prueba:	Gas Natural ( $I_{2H}$ ) = 8,7 mbar Gas Natural (I2E) = 8,7 mbar Gas Natural (I2S) = 8,7 mbar Propano Licuado ( $I_{3p}$ ) = 25 mbar
Diámetro Boquilla:	Gas Natural ( $I_{2H}$ ) = 2,51 mm Gas Natural (I2E) = 2.51 mm Gas Natural (I2S) = 2.85 mm Propano Licuado ( $I_{3p}$ ) = 1,40 mm

Este equipo debe instalarse únicamente en un recinto adecuadamente ventilado y conforme a las indicaciones del fabricante y a las normas vigentes. Lea completamente las instrucciones antes de instalar o usar este equipo.

# **HENNY PENNY 6 HEAD GAS PRESSURE FRYER SPECIFICATIONS**

Height	61" (155 cm)
Width	24" (61 cm)
Depth	41 <sup>3</sup> / <sub>4</sub> " (106 cm)
Floor Space	Approximately 7 sq. ft. (0.65 sq. m.)
Pot Capacity	6 head of chicken (20 lbs.) (9 kg) 130 lbs. shortening (59 kg)
Electrical	120 VAC, 1 Phase, 50/60 Hz, 10 Amp, 3 Wire Service 230 VAC, 1 Phase, 50 Hz, 3 Wire Service
Heating	Propane or Natural Gas; 100,000 btu/hr (105 MJ/hr)
Shipping Weight	Approximately 935 lbs. (424 kg)

## **NOTICE**

A data plate, located on the back shroud behind the lid, gives the information of the type of fryer, serial number, warranty date, and other information pertaining to fryer. Also, the serial number is stamped on the outside of the frypot. See figure below.

## TABLE OF CONTENTS

<b>Section</b>	<b>Page</b>
Section 1. INTRODUCTION .....	1-1
1-1 Introduction .....	1-1
1-2 Proper Care .....	1-1
1-3 Assistance .....	1-1
1-4 Safety .....	1-2
Section 2. INSTALLATION .....	2-1
2-1 Introduction .....	2-1
2-2 Unpacking .....	2-1
2-3 Selecting the Fryer Location .....	2-4
2-4 Leveling the Fryer .....	2-4
2-5 Ventilation of Fryer .....	2-5
2-6 Gas Supply .....	2-5
2-7 Gas Leak Test .....	2-8
2-8 Gas Pressure Regulator Setting .....	2-8
2-9 Electrical Requirements .....	2-9
Section 3. OPERATION .....	3-1
3-1 Operating Components .....	3-1
3-2 Lid Operation .....	3-3
3-3 Melt Cycle Operation .....	3-3
3-4 Switches and Indicators .....	3-3
3-5 Filling or Adding Shortening .....	3-6
3-6 Basic Operation .....	3-7
3-7 Care of Shortening .....	3-9
3-8 Filtering Instructions .....	3-9
3-9 Changing the Filter Envelope .....	3-11
3-10 Lighting and Shutdown of Burners .....	3-11
3-11 Cleaning the Frypot .....	3-12
3-12 Filter Pump Motor Protector-Manual Reset .....	3-13
3-13 Regular Maintenance Schedule .....	3-13
3-14 Preventive Maintenance .....	3-14
3-15 Programming .....	3-18
3-16 Special Program Mode .....	3-20
Section 4. TROUBLESHOOTING .....	4-1
4-1 Troubleshooting Guide .....	4-1
4-2 Error Codes .....	4-2
GLOSSARY .....	G-1

Distributors List - Domestic and International

## SECTION 1: INTRODUCTION

### 1-1. INTRODUCTION

The Henny Penny open fryer is a basic unit of food processing equipment. This unit is used only in institutional and commercial food service operations.

#### NOTICE

As of August 16, 2005, the Waste Electrical and Electronic Equipment directive went into effect for the European Union. Our products have been evaluated to the WEEE directive. We have also reviewed our products to determine if they comply with the Restriction of Hazardous Substances directive (RoHS) and have redesigned our products as needed in order to comply. To continue compliance with these directives, this unit must not be disposed as unsorted municipal waste. For proper disposal, please contact your nearest Henny Penny distributor.



### 1-2. PROPER CARE

As in any unit of food service equipment, the Henny Penny Pressure Fryer does require care and maintenance. Requirements for the maintenance and cleaning are contained in this manual and must become a regular part of the operation of the unit at all times.

### 1-3. ASSISTANCE

Should you require outside assistance, call your local independent distributor in your area, call Henny Penny Corp. at 1-800-417-8405 or 1-937-456-8405, or go to Henny Penny online at [www.hennypenny.com](http://www.hennypenny.com).



**1-4.  
SAFETY**

The instructions in this manual have been prepared to aid you in learning the proper procedures for your equipment. Where information is of particular importance or is safety related, the words NOTICE, CAUTION, or WARNING are used. Their usage is described below.

If a problem occurs during the first operation of a new unit, recheck the Installation Section of the Operator’s Manual.

Before troubleshooting, always recheck the Operation Section of the Operator’s Manual.

Where information is of particular importance or is safety related, the words DANGER, WARNING, CAUTION, or NOTICE are used. Their usage is described as follows:



SAFETY ALERT SYMBOL is used with DANGER, WARNING or CAUTION which indicates a personal injury type hazard.



NOTICE is used to highlight especially important information.



*CAUTION used without the safety alert symbol indicates a potentially hazardous situation which, if not avoided, may result in property damage.*



*CAUTION used with the safety alert symbol indicates a potentially hazardous situation which, if not avoided, could result in minor or moderate injury.*



**WARNING indicates a potentially hazardous situation which, if not avoided, could result in death or serious injury.**



**DANGER INDICATES AN IMMINENTLY HAZARDOUS SITUATION WHICH, IF NOT AVOIDED, WILL RESULT IN DEATH OR SERIOUS INJURY.**



## SECTION 2: INSTALLATION

### 2-1. INTRODUCTION

This section provides the installation and unpacking instructions for the Henny Penny PFG-.

#### NOTICE

Installation of this unit should be performed only by a qualified service technician.



**Do not puncture the fryer with any objects such as drills or screws as electrical shock or component damage could result.**

#### NOTICE

Any shipping damage should be noted in the presence of the delivery agent and signed prior to his or her departure.

### 2-2. UNPACKING INSTRUCTIONS

1. Cut and remove the plastic bands from the main box.
2. Remove the box lid and lift the main box off the fryer.
3. Remove four corner packing supports.
4. Cut the stretch film from around the carrier/rack box and remove it from the top of the fryer lid.
5. Cut and remove the metal bands holding the fryer to the pallet.



**All counterweights must be loaded before unlatching the lid, or personal injury could result.**

6. Remove the fryer from the pallet.



**Take care when moving the fryer to prevent personal injury. The fryer weighs approximately 935 lbs. (424 kg).**

**2-2.  
UNPACKING  
INSTRUCTIONS  
(CONT.)**

7. Remove the counterweights, which are strapped to the pallet under the fryer, from the pallet.



*Do not drop. The counterweights weigh approximately 18 lbs. (8.1 kg) each. Handle with care, or personal injury could result.*

8. Remove rear service cover.
9. Load the 4 weights into the counterweight assembly.
10. Replace rear service cover.



**To avoid personal injury and assure safe operation of unit, rear service cover must be in place.**

11. Cut warning tags from the lid assembly. The lid may now be unlatched.
12. Remove the accessories from inside the filter drain pan.



The fittings for installing the gas line are in a separate box, along with the accessories, in the filter drain pan.

13. Remove the protective paper from the fryer cabinet. Clean exterior surface with a damp cloth.

## Optional Ramp Unloading

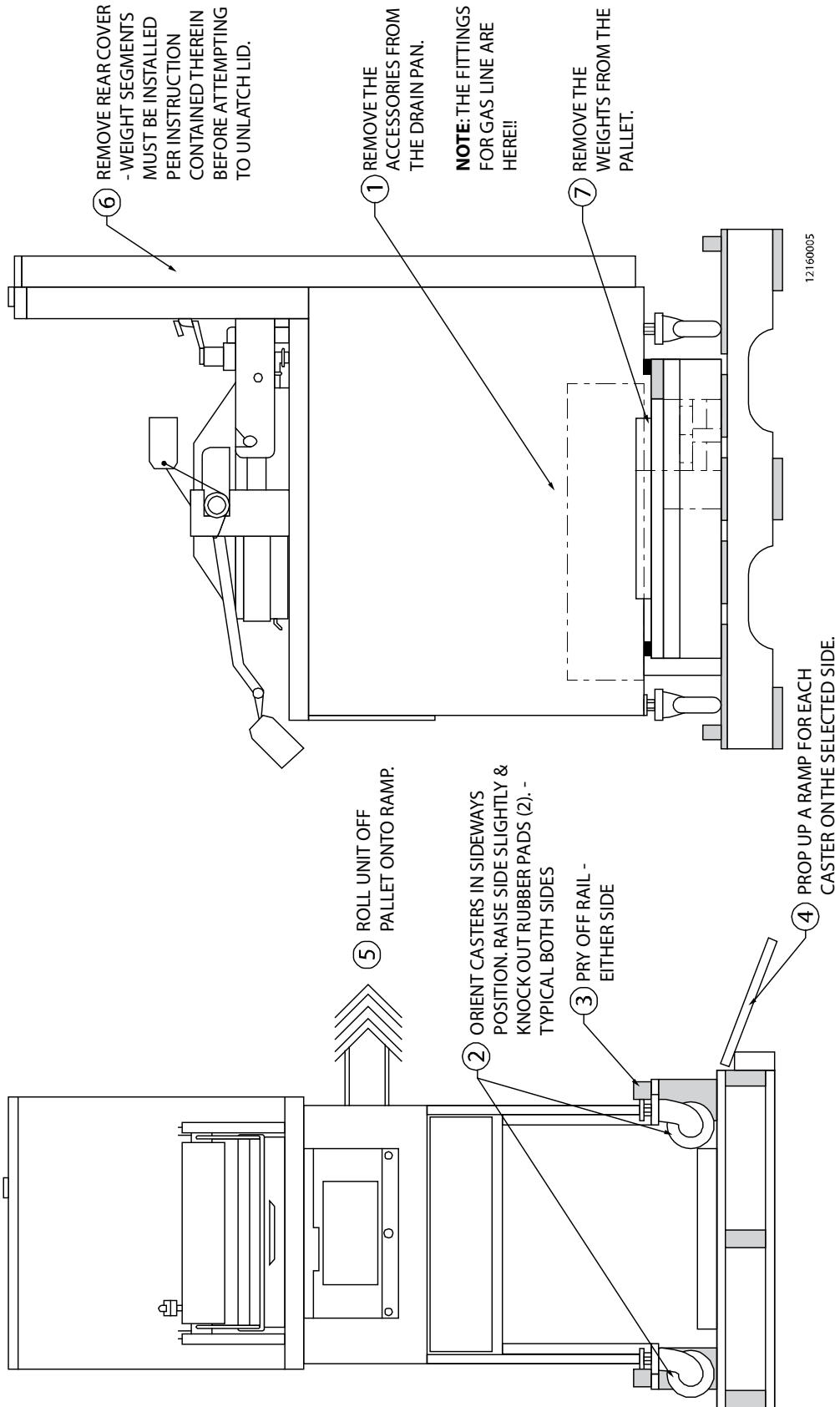

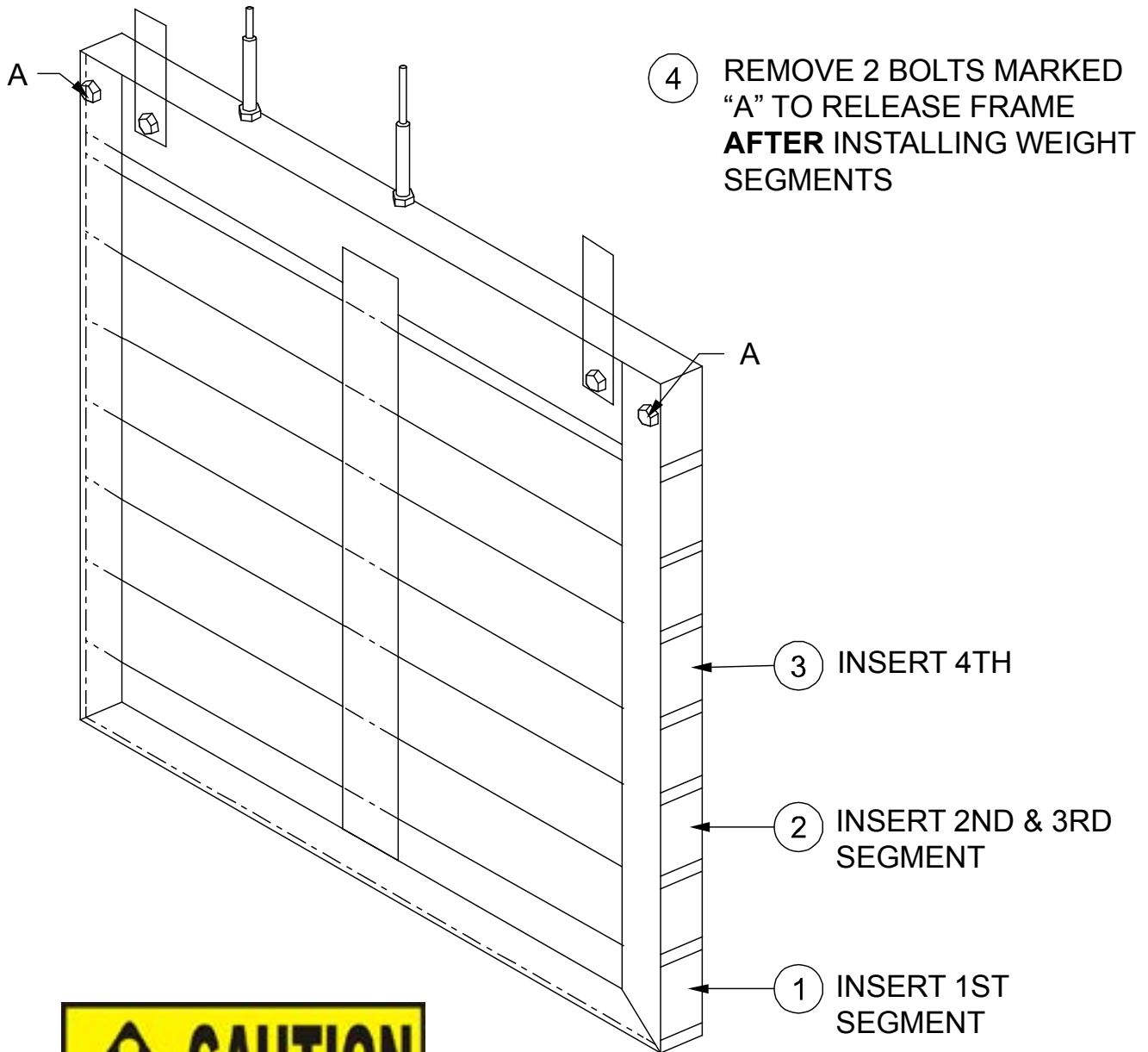

- \* EACH WEIGHT SEGMENT WEIGHS APPROXIMATELY 18 LBS. (8.1 KG) - HANDLE WITH CARE
- \* ALL SEGMENTS ARE IDENTICAL.
- \* ALL SEGMENTS MUST BE INSTALLED AND SECURED IN THE FRAM BEFORE ATTEMPTING TO UNLATCH LID.

12160007

**2-3.  
SELECTING THE  
LOCATION**

The proper location of the fryer is very important for operation, speed, and convenience. Choose a location which will provide easy loading and unloading without interfering with the final assembly of food orders. Operators have found that frying from raw to finish, and holding the product in a warmer provides fast, continuous service. Landing or dumping tables should be provided next to, at least, one side of the fryer. Keep in mind the best efficiency will be obtained by a straight line operation, i.e., raw in one side and finish out the other side. Order assembly can be moved away with only a slight loss of efficiency. To properly service the fryer, 24 inches (60.96 cm) of clearance is needed on all sides of the fryer. Access for servicing can be attained by removing a side panel. Also, at least 6 inches (15.24 cm) around the base of the unit is needed for proper air supply to the combustion chamber.

**CAUTION  
FIRE HAZARD**

*To avoid a fire, install the fryer with minimum clearance from all combustible and noncombustible materials, 6 inches (15.24 cm) from side and 6 inches (15.24 cm) from back. If installed properly, the gas fryer is designed for operation on combustible floors and adjacent to combustible walls.*

*To avoid fire and ruined supplies, the area under the 390 fryer should not be used to store supplies.*

*Do not spray aerosols in the vicinity of this appliance while it is in operation.*

**WARNING  
BURN RISK**

**To prevent severe burns from splashing hot shortening, position and install fryer to prevent tipping or movement. Restraining ties may be used for stabilization.**

**2-4.  
LEVELING THE  
FRYER**

For proper operation, level the fryer from side to side and front to back, using level on the flat areas around the frypot collar.

**! DANGER**

**FAILURE TO FOLLOW THESE LEVELING INSTRUCTIONS CAN RESULT IN SHORTENING OVERFLOWING THE FRYPOT WHICH COULD CAUSE SERIOUS BURNS, PERSONAL INJURY, FIRE, AND/OR PROPERTY DAMAGE.**

**2-5.  
VENTILATION OF  
FRYER**

The fryer must be located with provision for venting into adequate exhaust hood or ventilation system. This is essential to permit efficient removal of the flue gases and frying odors. Special precaution must be taken in designing an exhaust canopy to avoid interference with the operation of the fryer. We recommend you consult a local ventilation or heating company to help in designing an adequate system.

**NOTICE**

Ventilation must conform to local, state, and national codes. Consult your local fire department or building authorities.

**2-6.  
GAS SUPPLY**

The gas fryer is factory available for either natural or propane gas. Check the data plate on the right side panel of the cabinet to determine the proper gas supply requirements. The minimum supply for natural gas is 7 inches water column (1.74 kPa), and 10 inches water column (2.49 kPa) for propane.

**WARNING  
EXPLOSION RISK**

**Do not attempt to use any gas other than that specified on the data plate. Incorrect gas supply could cause a fire or explosion resulting in severe injuries and/or property damage.**

Please refer below for the recommended hookup of the fryer to main gas line supply.

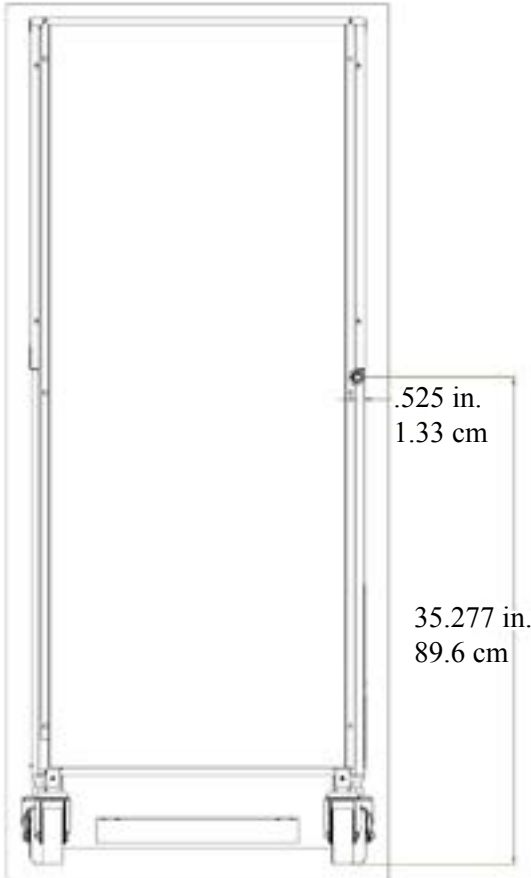

**WARNING**

**To avoid possible serious personal injury:**

- Installation must conform with local, state, and national codes, and be in accordance with Canadian Gas Authority Standard CSA B149-& 2, Installation Codes - Gas Burning Appliances and in accordance with Australian Gas Association current edition of AS5601 Gas Installations.**
- The fryer and its manual shutoff valve must be disconnected from the gas supply piping system during any pressure testing of that system at test pressures in excess of 1/2 psig (3.45kPa) (34.47mbar)**  
**(continued to next page)**



**2-6.  
GAS SUPPLY  
(CONT.)**

**WARNING**

- **The fryer must be isolated from the gas supply piping system by closing its manual shutoff valve during any pressure testing of the gas supply piping system at test pressures equal to or less than 1/2 psig (3.45 kPa)(34.47 mbar).**
- **A standard 3/4 inch, black steel pipe and malleable fittings should be used for gas service connections.**
- **Do not use cast iron fittings.**
- **Although 3/4 inch size pipe recommended, piping should be of adequate size and installed to provide a supply of gas sufficient to meet the maximum demand without undue loss of pressure between the meter and the fryer. The pressure loss in the piping system should not exceed 0.3 inch water column (0.747 mbar).**

Provisions should be made for moving the fryer for cleaning and servicing. This may be accomplished by:

1. Installing a manual gas shutoff valve and disconnect union, or
2. Installing a heavy-duty (min. 3/4 inch) design A.G.A. certified connector which complies with standard connectors for moveable gas appliances. ANSI Z21.69 or CAN/CSA 6.16. Also, a quick-disconnect coupling which complies with the Standard for Quick-Disconnect Devices for use with Gas Fuel, ANSI Z21.41 or CAN 1-6.9. Also, adequate means must be provided to limit the movement of the fryer without depending on the connector and any quick-disconnect device or its associated piping to limit the fryer movement.
3. See the illustration on the following page for the proper connections of the flexible gas line and cable restraint.

**NOTICE**

The cable restraint limits the distance the fryer can be pulled from the wall. For cleaning and servicing the fryer, the cable must be unsnapped from the unit and the flexible gas line disconnected. This will allow better access to all sides of the fryer. The gas line and cable restraint must be reconnected once the cleaning or servicing is complete.

## GAS PIPING

### RIGHT

MINIMUM PULL of equipment away from wall permissible for accessibility to Quick Disconnect Device

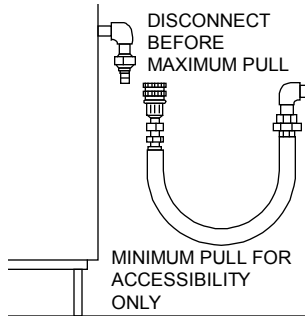

### WRONG

AVOID SHARP BENDS AND KINKS when pulling equipment away from wall. (Maximum pull will kink ends, even if installed properly, and reduce Connector life.)

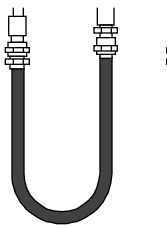
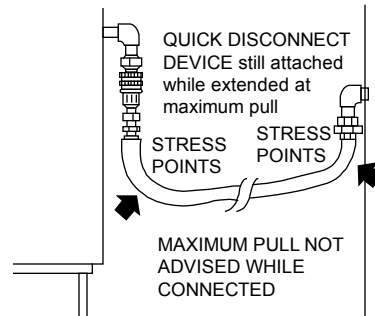

### RIGHT

Couplings and hose should be installed in the same plane as shown at left. DO NOT OFFSET COUPLINGS -- this causes torsional twisting and undue strain causing premature failure

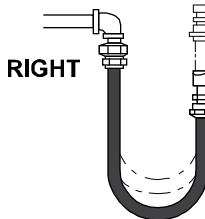
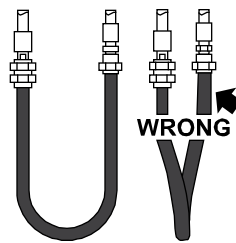

### RIGHT

This is the correct way to install metal hose for vertical traverse. Note the single, natural loop. Allowing a sharp bend, as shown at right, strains and twists the metal hose to a point of early failure at the coupling

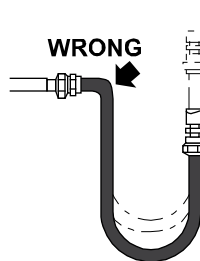

### WRONG

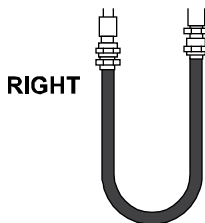

### RIGHT

Maintain the minimum or larger bending diameter between the couplings for longest life. Closing in the diameter at the coupling, as shown at right, creates double bends causing work work fatigue failure of the fittings.

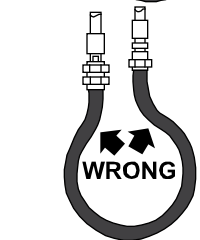

### WRONG

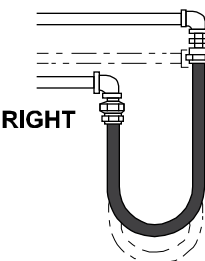

### RIGHT

In all installations where "self-draining" is not necessary, connect metal hose in a vertical loop. DO NOT CONNECT METAL HOSE HORIZONTALLY...unless "self-draining" is necessary, then use support on lower plane as shown at left.

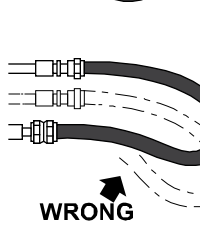

### WRONG

## CABLE RESTRAINT

Please refer to the illustration below when installing cable restraint on all moveable gas fryers.

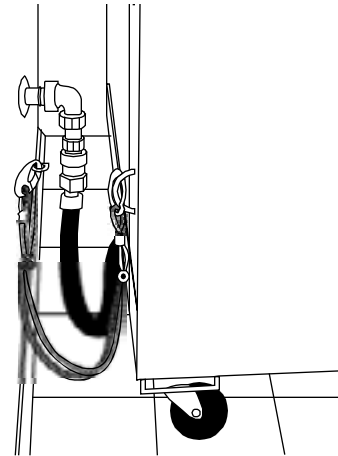

I-bolt is to be secured to the building using acceptable building construction practices.



## DRY WALL CONSTRUCTION

Secure I-bolt to a building stud DO NOT attach to dry wall only. Also, locate the I-bolt at the same height as the gas service. Preferred installation is approximately six inches to either side of service. Cable restraint must be at least six inches shorter than flexible gas line.



Utilize elbows when necessary to avoid sharp kinks or excessive bending. For ease of movement, install with a "lazy" loop. gas appliance must be disconnected prior to maximum movement. (Minimum movement is permissible for hose disconnection).

12160004

**2-7.  
GAS LEAK TEST**

**NOTICE**

Prior to turning the gas supply on, be sure the gas valve knob on the gas control valve is in the OFF position. The word OFF is at the bottom of the knob when the valve is closed.

Upon initial installation, and after moving the unit, the piping and fittings should be checked for gas leaks. A simple checking method is to turn on the gas, and brush all connections with a soap solution. If bubbles occur, it indicates escaping gas. In this event, the piping connection must be redone.



**To avoid fire or explosion, never use a lighted match or open flame to test for gas leaks. Ignited gas could result in severe personal injury and/or property damage.**

**2-8.  
GAS PRESSURE  
REGULATOR  
SETTING**

The gas pressure regulator on the gas control valve is factory set as follows:

- Natural: 3.5 inches water column (0.87 kPa)
- Propane: 10.0 inches water column (2.49 kPa)

**NOTICE**

The gas pressure regulator has been set by Henny Penny and is not to be adjusted by the user.



**MAKE SURE GAS PRESSURE IS SET CORRECTLY. FAILURE TO DO SO CAN RESULT IN SHORTENING OVERFLOWING THE FRYPOT, WHICH COULD CAUSE SERIOUS BURNS, PERSONAL INJURY, FIRE, AND/OR PROPERTY DAMAGE.**

**2-8.  
GAS PRESSURE  
REGULATOR  
SETTING  
(CONT.)**



Figure 1



Figure 2



Figure 3

**Measuring Gas Pressure**

1. Locate the pressure tap hole or fitting on the side of the gas valve. Remove the pipe plug from the valve or fitting circled in Figure 1.
2. Screw a pressure tap fitting into the valve or the fitting on the side of the valve circled in Figure 2.
3. Place one end of a vacuum hose on the pressure tap fitting and the other end on the manometer as shown in Figure 3.
4. Turn the fryer "ON".
5. Allow the fryer to reach full burn.
6. The pressure reading on the manometer should be 3.5" of water column for Natural gas and 10" of water column for LP gas.
7. Turn the fryer off.
8. Remove the pressure tap fitting.
9. Place the pipe plug back into the valve or the fitting on the valve.

**NOTICE**

Notify a qualified service technician if gas pressure differs from factory settings mentioned in this manual

**2-9.  
ELECTRICAL  
REQUIREMENTS**

The gas fryer requires 120 volt, 60 Hertz, 1 phase, 10 amp, 3-wire grounded (earthed) service, or 230 volt, 50 Hertz, 1 phase, 5 amp, service. The 120 volt gas fryer is factory equipped with a grounded (earthed) cord and plug for your protection against shock, and should be plugged into a three-prong grounded (earthed) receptacle. Do not cut or remove grounding (earthing) prong. A wiring diagram is located behind the right side panel, and can be accessed by removing the side panel. The 230 volt plug must conform to all local, state, and national codes.



**To avoid electrical shock, do not disconnect the ground (earth) plug. This fryer must be adequately and safely grounded (earthed). Refer to local electrical codes for correct grounding (earthing) procedures or in absence of local codes, with The National Electrical Code, ANSI/ NFPA No. 70- (the current edition). In Canada, all electrical connections are to be made in accordance with CSA C22.1, Canadian Electrical Code Part 1, and/or local codes.**

**To avoid electrical shock, this appliance must be equipped with an external circuit breaker which will disconnect all ungrounded (unearthed) conductors. The main power switch on this appliance does not disconnect all line conductors.**

**BOIL-OVER PREVENTION IN HENNY PENNY FRYERS**



**FAILURE TO FOLLOW THESE INSTRUCTIONS CAN RESULT IN SHORTENING OVERFLOWING THE FRYPOT WHICH COULD CAUSE SERIOUS BURNS, PERSONAL INJURY, FIRE, AND/OR PROPERTY DAMAGE.**

- **THE SHORTENING SHOULD BE STIRRED ONLY DURING THE MORNING START-UP PROCEDURE. DO NOT STIR THE SHORTENING AT ANY OTHER TIME.**
- **FILTER THE SHORTENING AT LEAST TWICE A DAY.**
- **FILTER ONLY WHEN “COOL” IS DISPLAYED.**
- **BRUSH ALL CRACKLINGS FROM FRYPOT SURFACES AND THE COLD ZONE DURING THE FILTERING PROCESS.**
- **MAKE SURE THE FRYER IS LEVEL.**
- **BE CERTAIN THE SHORTENING IS NEVER ABOVE THE UPPER FRYPOT LEVEL INDICATOR LINES.**
- **BE CERTAIN THAT THE GAS CONTROL VALVE AND BURNERS ARE PROPERLY ADJUSTED (GAS UNITS ONLY).**
- **USE RECOMMENDED PRODUCT LOAD SIZE.**

**FOR ADDITIONAL INFORMATION ON THESE INSTRUCTIONS, REFER TO THE HENNY PENNY OPERATOR’S MANUAL AND THE KFC STANDARDS LIBRARY.**

**FOR ASSISTANCE, CALL THE HENNY PENNY SERVICE DEPARTMENT AT  
1-800-417-8405 OR 1-937-456-8405.**



## SECTION 3: OPERATION

### 3-1. OPERATING COMPONENT

#### **Power/Pump Switch**

A three way switch with center OFF position; move the switch to the position marked POWER to operate the fryer; move the switch to the position marked PUMP to operate the filter pump; certain conditions must be met prior to operation of the filter pump; these conditions are covered later in this section

#### **Frypot**

This reservoir holds the cooking shortening, and is designed to accommodate the burner tubes, 6 head of product and an adequate cold zone for collection of cracklings

#### **Carrier**

This stainless steel carrier consists of five racks which contain the food product during and after frying

#### **Drain Valve**

A two-way ball valve, normally in the closed position; turn the handle to drain the shortening from the frypot into the filter drain pan

#### **Drain Interlock Switch**

A microswitch that provides protection for the frypot in the event an operator inadvertently drains the shortening from the frypot while the main switch is in the POWER position; the switch is designed to automatically shut off the heat when the drain valve is opened

#### **Shortening Mixing System**

A shortening mixing capability to help ensure shortening is properly mixed to prevent an accumulation of moisture and hence boiling action in the pot; the filter pump is activated by the controls, at preset intervals, to mix the shortening

#### **Lid Latch**

A mechanical catch on the front of the lid which engages a bracket on the front of the frypot; this device holds the lid down while the lid is being locked into place, but is not to hold pressure in the frypot.

#### **Filter Drain Pan**

The removable pan that houses the filter and catches the shortening when it is drained from the frypot; also used to remove and discard old shortening

#### **Filter Union**

Connects the filter to the filter pump, and allows easy removal of the filter and drain pan



When hot shortening is in this pan, use extreme care to avoid burns.



**3-1.  
OPERATING  
COMPONENT**



**Figure 3-1**

**High Limit**

This high temperature control senses the temperature of the shortening; if the temperature of the shortening exceeds 450°F (230°C), this control will open and shut off the heat to the frypot; when the temperature of the shortening drops to a safe operation limit, the control must be manually reset by pressing the red reset button, located under the control panel, in the front of the fryer

**Ignition Modules**

The two ignition modules send 24 volts to the gas control valve and high voltage to the ignitors

**Spark Ignitors**

When the pilots are being lit, the spark ignitors are electrically energized and the tip of the ignitors spark to ignite the pilot lights

**Flame Sensors**

Sense the pilot lights when the power switch is turned on; if the pilots go out, or do not light, the flame sensors shut the gas off, via the modules

**Gas Control Valve**

A dual controller, in which, one side of the valve controls the pilot light and the other side controls the main burner

**Airflow Switch**

Senses the flow of air coming from the blower; if the airflow is reduced below a set amount, the switch cuts power to the gas control valve, which shuts down the burners

**CAUTION**

*To avoid property damage, do not tamper with or disassemble this component. It is set and sealed from the factory and is not to be adjusted.*

**Blower**

Adds the proper amount of air into the burner tubes, so an efficient combustion takes place, and also, pulls the flue gases out to the flue

**Air Valve**

Pumps air into the shortening, periodically, to keep the shortening at a uniform temperature; this only functions when the unit has been sitting idle for a period of time and when heating up from a cold start.

**3-2.  
LID OPERATION**

**To close lid:**

1. Lower the lid until latch comes into contact with the pot.

**To open lid:**

1. Unlatch the front lid latch.
2. Lift up on handle to raise lid.

**3-3.  
MELT CYCLE  
OPERATION**

If the shortening is below 185°F (77°-85°C) with the POWER/ PUMP switch in the POWER position, the fryer enters the Melt Cycle. The shortening is heated slowly to prevent scorching of the shortening. The heat cycles on and off to ensure slow melting of shortening. At 185°F (85°C), the heat stays on until 250°F (121°C), the Cool Mode, is reached. To exit the Cool Mode, press the COOL button.

See Filling and Adding Shortening Section.

**3-4.  
SWITCHES AND  
INDICATORS**

Refer to image at end of this section.

**Product Selection Buttons**

Select the number of heads, or product, to be cooked by pressing the button below the menued item; shortening will then heat to drop temperature of that item.

Pressing the same button again begins the Cook Cycle; the display changes from “DROP” to counting down the cook time in minutes and seconds.

At the end of the Cook Cycle, the alarm sounds and the display reads “DONE”; press the cycle button that is flashing, to stop the alarm ; the fryer then resets to the Cool Mode.

**NOTICE**

A Cook Cycle can be aborted at any time by pressing and holding the product button.

**Time/Temperature Display**

A four digit LED type display which shows the remaining cook time during Cook Cycles and also the shortening temperature on demand from the operator.

**Heat Indicator**

Illuminates whenever the control calls for heat; when shortening temperature has been reached, the heat light goes off.

**HI Temperature Indicator**

The display reads “HI” if the shortening temperature is 40° F above the setpoint.

**3-4.  
SWITCHES AND  
INDICATORS  
(CONT.)**

**Drop Indicator**

The display reads “DROP” when the shortening has reached the setpoint temperature (will read “DROP” 2° before setpoint and 4° above setpoint).

**Done Indicator**

The display reads “DONE” at the end of the Cook Cycle.

**Temperature Button**

Press this button to read the temperature of the shortening during a Cook Cycle.

**SCAN Button**

Pressing this button toggles through the items being programmed.

**FUNCTION Button**

Used in the programming of the controls.

**EXIT FILL Button**

After filtering the fryer, if in the filter lockout mode, the display reads FILL”, and the EXIT FILL button must be pressed.

**EXIT COOL Button**

After cooking, or filtering the shortening, the temperature automatically goes into the Cool Mode, which keeps shortening at a lower temperature; this temperature extends the shortening life and minimizes the time to heat the shortening for the next Cook Cycle;EXIT COOL button must be pressed to heat up to setpoint temperature.



**ALTHOUGH THE DISPLAY WILL READ  
“COOL” DURING THE STANDBY MODE, THE  
SHORTENING IS HOT AND WILL CAUSE  
BURNS.**

## SMS Controls

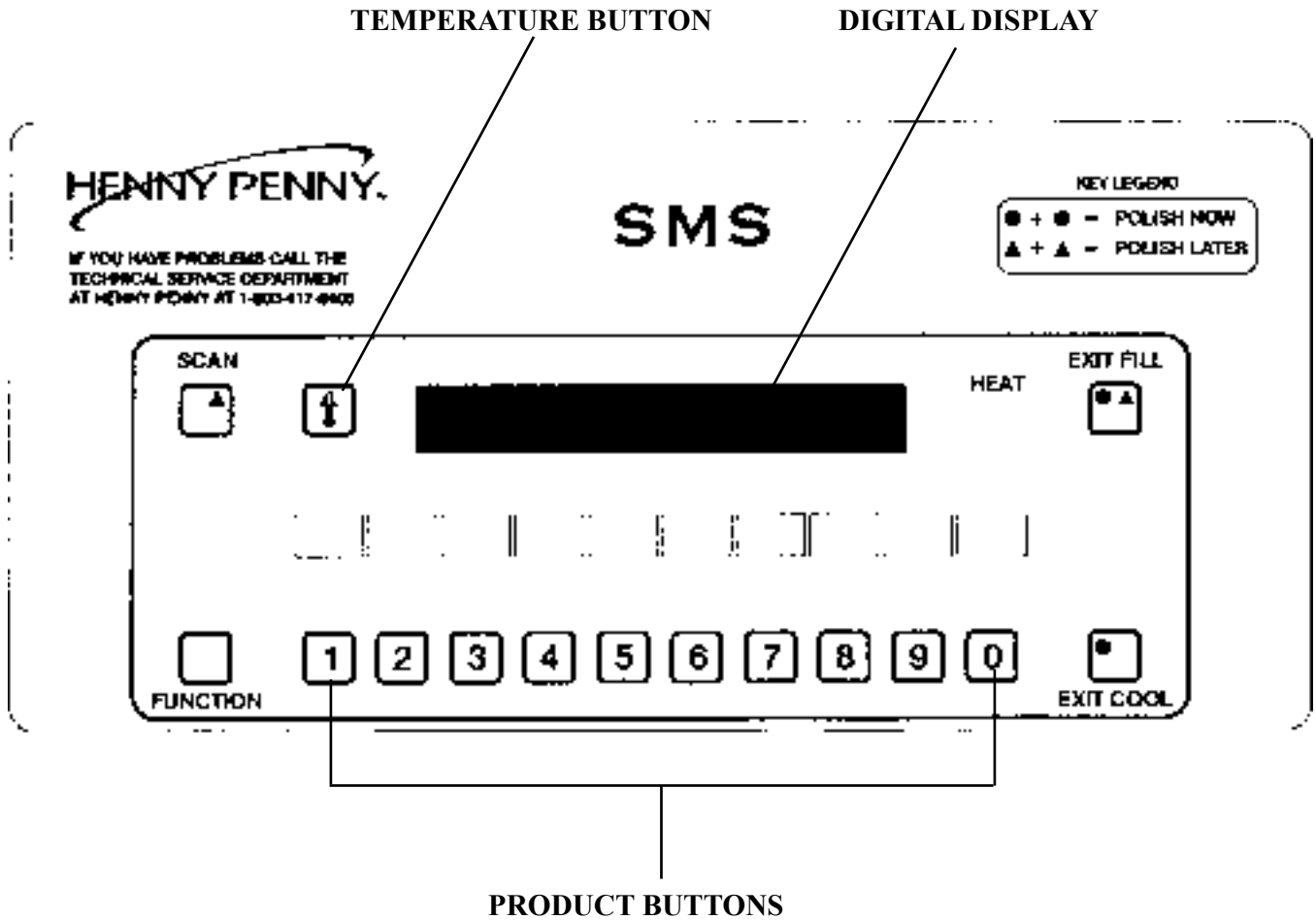

Figure 3-2

**3-5.  
FILLING  
OR ADDING  
SHORTENING**



**Figure 3-3**

**CAUTION**

*The shortening level must always be above the heating elements when the fryer is heating and at the frypot level indicators on the rear of the frypot (Figure 3-3). Failure to follow these instructions could result in a fire and/or damage to the fryer.*

*When using solid shortening, it is recommended to melt the shortening on an outside heating source before placing it in the frypots. The burner tubes must be completely submerged in shortening. Fire or damage to the frypot could result.*

1. It is recommended that a high quality frying shortening be used in the open fryer. Some low grade shortenings have a high moisture content and will cause foaming and boiling over.

**WARNING  
BURN RISK**

**To avoid severe burns when pouring hot shortening into frypot, wear gloves and take care to avoid splashing.**

2. The gas model requires 130 lbs. (59 Kg.) of shortening. The frypot has 4 level indicator lines inscribed on the rear wall of the frypot which show when the heated shortening is at the proper level. Figure 3-3.
3. Cold shortening should be filled to the lower indicators.

**DANGER  
OVERFLOW RISK**

**BE CERTAIN THE SHORTENING IS NEVER ABOVE THE UPPER LEVEL INDICATOR LINES. FAILURE TO FOLLOW THESE INSTRUCTIONS CAN RESULT IN SHORTENING OVERFLOWING THE FRYPOT CAUSING SERIOUS BURNS, PERSONAL INJURY, FIRE AND/OR PROPERTY DAMAGE.**

For complete instructions, refer to KFC's Standards Library.

**3-6.**  
**BASIC OPERATION**

Follow the procedure below on the initial start-up of the fryer, and each time the fryer is brought from a cold, or shut down condition, back into operation. These are basic, general instructions. Be sure to follow KFC's Standards Library when operating the fryer.

1. Make sure the frypot is filled with shortening to 2 the lower level indicators



**DO NOT OVERLOAD, OR PLACE PRODUCT WITH EXTREME MOISTURE CONTENT INTO THE RACKS. 20 LBS. (9.0 KG.) IS THE MAXIMUM AMOUNT OF PRODUCT PER FRYPOT. FAILURE TO FOLLOW THESE INSTRUCTIONS CAN RESULT IN SHORTENING OVERFLOWING THE FRYPOT WHICH COULD CAUSE SERIOUS BURNS, PERSONAL INJURY, FIRE AND/OR PROPERTY DAMAGE.**

2. Turn the POWER/PUMP switch to the POWER position and press the appropriate product button to select the amount of product to be cooked.



The controls have a 45 second delay from when the power switch is turned on, to when the burners ignite.

All safety devices shut off the gas supply to the burner. Follow the above procedures to restart the fryer. Notify a qualified service technician if the shut down is repeated.

3. Stir the shortening as it's heating up from a cold start. Be sure to stir down into the cold zone.



**DO NOT STIR THE SHORTENING AT ANY OTHER TIME EXCEPT AT MORNING START-UP. FAILURE TO FOLLOW THESE INSTRUCTIONS CAN RESULT IN SHORTENING OVERFLOWING THE FRYPOT WHICH COULD CAUSE SERIOUS BURNS, PERSONAL INJURY, FIRE, AND/OR PROPERTY DAMAGE.**

**3-6.**  
**BASIC OPERATION**  
**(CONT.)**

4. Allow fryer to heat until digital display shows “DROP”.  
(Press the EXIT COOL button if the display shows “COOL”).

**NOTICE**

The heat cycles on and off approximately 10 degrees before the setpoint temperature, to help prevent overshooting the setpoint temperature.(proportional control)

5. Before loading product onto the racks, lower racks into the hot shortening to keep the product from sticking to the racks.
6. Slide racks of breaded product into carrier on the lid, starting with the bottom tier.
7. Lower and latch the lid down and press the appropriate product button.
8. At the end of the cycle, an alarm sounds, and the display shows “DONE”. At this time, press the appropriate product button.
9. Unlatch and raise the lid cautiously.
10. Using the rack handles, remove the racks of product from the carrier, starting with the top rack.

**NOTICE**

In the event of a power failure, no attempt should be made to operate the fryer. The fryer is equipped with an automatic ignition system and cannot be operated without electrical power.

**3-7.  
CARE OF THE  
SHORTENING**

**⚠ DANGER**  
**OVERFLOW RISK**

**FOLLOW THE INSTRUCTIONS BELOW TO AVOID SHORTENING OVERFLOWING THE FRYPOT, WHICH COULD RESULT IN SERIOUS BURNS, PERSONAL INJURY, FIRE, AND/OR PROPERTY DAMAGE.**

1. To protect the shortening when the fryer is not in immediate use, the fryer should be put into the Cool Mode.
2. Frying breaded products requires filtering to keep the shortening clean. The shortening should be filtered at least twice a day: after lunch rush and at the end of the day.
3. Maintain the shortening at the proper cooking level. Add fresh shortening as needed.
4. Do not overload the baskets with product (20 lb (9.0 kg max), or place product with extreme moisture content into baskets.

**⚠ DANGER**  
**FIRE HAZARD**

**WITH PROLONGED USE, THE FLASHPOINT OF SHORTENING IS REDUCED. DISCARD SHORTENING IF IT SHOWS SIGNS OF EXCESSIVE SMOKING OR FOAMING. SERIOUS BURNS, PERSONAL INJURY, FIRE, AND/OR PROPERTY DAMAGE COULD RESULT.**

**3-8.  
FILTERING OF  
SHORTENING**

The Henny Penny gas 6 head fryer, Model OFG-, should be cleaned and the shortening must filtered and polished at least twice daily: after lunch rush and at the end of the day. Refer to KFC's Standards Library.

Filter shortening immediately following a Cook Cycle when the shortening temperature is in the "COOL" mode.

**CAUTION**

*Drain the shortening at 250° F (121° C) or less. Higher temperatures cause cracklings to burn on the steel frypot surfaces after the shortening has drained.*



**3-8.  
FILTERING OF  
SHORTENING  
(CONT.)**



**ONLY FILTER WHEN “COOL” IS DISPLAYED. FAILURE TO DO SO CAN RESULT IN SHORTENING OVERFLOWING THE FRYPOT, CAUSING SERIOUS BURNS, PERSONAL INJURY, FIRE, AND/OR PROPERTY DAMAGE.**

High volume cooking could cause the cold zone to fill quicker with cracklings and cleaning may be required more often. Part of the filtering process involves removing cracklings from the cold zone of the frypot.

1. Turn COOK/PUMP switch to OFF position..
2. Make sure filter drain pan is under fryer and the filter union is fastened to the filter standpipe, coming out of the pan.



**The filter drain pan must be as far back under fryer as it will go, and the cover in place. Be sure the hole in the cover lines up with the drain before opening the drain. Failure to follow these instructions causes splashing of shortening and could result in personal injury.**

**Surfaces of fryer and racks will be hot. Use care when filtering to avoid getting burned.**

Shortening Stirrer

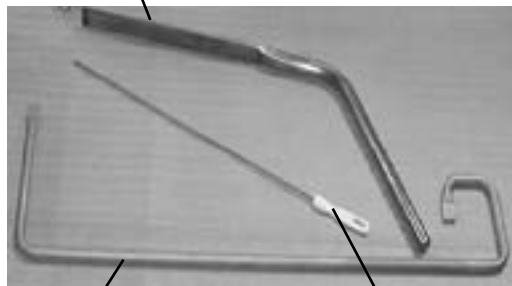

Drain Cleanout Rod

Small White Brush

3. Remove cooking racks and carrier, and wipe bottom of lid. Tilt lid out of the way to clean frypot.
4. Pull drain handle towards you to open drain valve. The handle should point straight out to the front of the fryer. Use large white brush to clean cracklings from the burner tubes and from sides and bottom of frypot as shortening drains. Use the drain cleanout rod to push cracklings through drain opening in bottom of frypot if necessary. Using the small straight white brush, clean between the burner tubes and the frypot wall.



**BRUSH ALL CRACKLINGS FROM FRYPOT SURFACES AND THE COLD ZONE DURING THE FILTERING PROCESS. FAILURE TO DO SO CAN RESULT IN SHORTENING OVERFLOWING THE FRYPOT, WHICH COULD CAUSE SERIOUS BURNS, PERSONAL INJURY, FIRE AND/OR PROPERTY DAMAGE.**

**3-8.  
FILTERING OF  
SHORTENING  
(CONT.)**

5. Scrape cracklings and crackling ring from frypot and discard. Do not let cracklings drain into filter drain pan. These cracklings can cause a burned taste in gravy. Wipe all surfaces with a clean damp towel. If water drops into cold zone, dry with towel before pumping shortening back into the frypot.
6. Return drain handle to the closed position to close the drain.
7. Turn POWER/PUMP switch to PUMP, and when all shortening has been pumped into frypot swing drain handle to the closed position to close the drain.



**IF THERE ARE AIR BUBBLES COMING UP IN THE SHORTENING, IT'S POSSIBLE THAT THE FILTER CONNECTION AT THE UNION ON THE FILTER TUBE IS NOT TIGHTENED PROPERLY. IF SO, TURN OFF THE PUMP AND USE PROTECTIVE CLOTH OR GLOVE WHEN TIGHTENING THE UNION. THIS UNION WILL BE HOT AND SEVERE BURNS COULD RESULT.**

**3-9.  
CHANGING THE  
FILTER ENVELOPE**

The filter envelope should be changed after 10-12 filterings, or whenever it becomes clogged with crumbs. Refer to KFC's Standards Library.



**Use protective cloth or glove when disconnecting the filter union or severe burns could result.**

**If the filter pan is moved while full of shortening, use care to prevent splashing, or severe burns could result.**



Be sure that the filter screens, crumb catcher, filter clips and the standpipe are thoroughly dry before assembly of the filter envelope or water will dissolve the filter paper.

**3-10.  
LIGHTING AND  
SHUTDOWN OF THE  
BURNERS**

**To light burner:**

1. Turn POWER/PUMP switch to the OFF position.
2. Rotate gas valve knob clockwise to the OFF position and wait at least five(5) minutes before continuing to next step.
3. Rotate gas valve knob counter clockwise to the ON position.
4. Place the electrical POWER/PUMP switch to POWER position. The burner will light until shortening reaches a preset temperature.
5. Press desired product button after temperature is displayed.

**To shutdown burner:**

1. Turn POWER/PUMP switch to the OFF position.
2. Rotate gas valve knob to the OFF position.

This fryer is equipped with a grounded (earthed) cord and plug for your protection against shock, and should be plugged into a 3 prong grounded (earthed) receptacle. Do not cut or remove grounding prong.

After the initial installation of the fryer, as well as before every change of shortening, the frypot should be thoroughly cleaned as follows:

1. Turn the POWER/PUMP switch to OFF position, and unplug unit from wall receptacle.



**The filter drain pan must be as far back under fryer as it will go, and the cover in place. Be sure the hole in the cover lines up with the drain before opening the drain. Failure to follow these instructions causes splashing of shortening and could result in personal injury.**

**Moving the fryer or filter drain pan while containing hot shortening is not recommended. Hot shortening can splash out and severe burns could result.**

2. If hot shortening is present in the frypot, it must be drained by slowly pulling the drain handle out towards you.
3. Close the drain valve and discard the shortening.
4. Raise lid, remove the racks and carrier from lid, and tilt lid back, so that the lid won't interfere with cleaning.

**3-11.  
CLEANING THE  
FRYPOT**

**3-11.  
CLEANING THE  
FRYPOT  
(CONT.)**

5. Refer to KFC's Standard's Library on cleaning instructions.

**CAUTION**

*If the cleaning solution in the frypot starts to foam and boil over, immediately turn the POWER Switch to OFF or damage to components could result.*

*Do not use steel wool, other abrasive cleaners or cleaners/sanitizers containing chlorine, bromine, iodine or ammonia chemicals, as these will deteriorate the stainless steel material and shorten the life of the unit.*

*Do not use a water jet (pressure sprayer) to clean the unit, or component damage could result.*

**NOTICE**

Make sure the inside of the frypot, the drain valve opening, and all parts that come in contact with the new shortening are as dry as possible.

**3-12.  
FILTER PUMP MOTOR  
PROTECTOR-MANUAL  
RESET**

The filter pump motor is equipped with a manual reset button, located on the rear of the motor, in case the motor overheats. If motor won't run, wait about 5 minutes before attempting to reset this protective device to allow motor to cool. Remove the access panel on the left side panel of the unit to reset the button. It takes some effort to reset, and a screwdriver can be used to help reset the button.



**To prevent burns caused by splashing shortening, turn the unit's main power switch to the OFF position before resetting the filter pump motor's manual reset protection device.**

**3-13.  
REGULAR  
MAINTENANCE  
SCHEDULE**

The Henny Penny open fryer does require care and proper maintenance. The table below provides a summary of scheduled maintenance. The following paragraphs provide step-by-step preventive maintenance procedures to be performed by the operator.

**Procedure**

- Filtering of shortening
- Checking/cleaning dilution box
- Cleaning the Nylatrons
- Changing of shortening
- Cleaning blower
- Changing the filter envelope
- Cleaning the frypot
- Lubricate lid rollers
- Inspect counter weight cables

**Frequency**

- See KFC's Standards Library
- Monthly-see Preventive Maint. Section
- Monthly-see Preventive Maint. Section
- See KFC's Standards Library
- Annually-see Preventive Maint. Section
- See KFC's Standards Library
- See KFC's Standards Library
- Annually-see Preventive Maint. Section
- Annually

**3-14.  
PREVENTIVE  
MAINTENANCE**

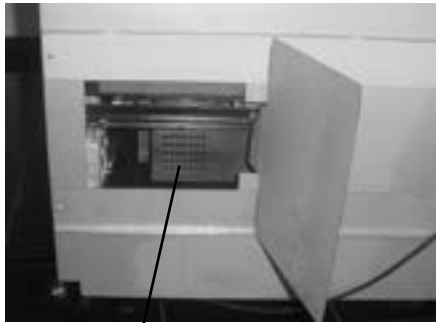

**Dilution Box**



**If moving fryer to perform preventive maintenance:**

- **Gas supply should be turned off to avoid fire or explosion.**
- **Electrical supply should be unplugged or wall circuit breaker turned off to avoid electrical shock.**

**Checking/Cleaning Dilution Box - Monthly**

Cleaning the dilution box helps to ensure the unit operates efficiently and with few failures.

1. Make sure unit is off, and close and lock the lid.



**Lid should be in locked down position. Failure to do so could result in personal injury.**

2. Unscrew the wingnut on the lower left back access panel of the fryer, and remove access panel. Clean the dilution box with a cloth, or brush. Make sure the holes in the box are free of debris. Replace back shroud when finished.



Depending on the breading location and conditions within the kitchen area, the dilution box may need cleaned more often.

**Cleaning the Nylatrons - Monthly**

1. Spray Henny Penny biodegradable, food safe, foaming degreaser (part no. 12226) on Nylatrons.
2. Raise lid up and down several times to spread the degreaser.
3. Wipe Nylatrons to remove food soil, grease, and degreaser residue.

**Lubricating Lid Rollers - Annually**

The lid rollers, in the back of the fryer, should be lubricated at least once a year, to allow the lid easy movement.

1. Remove the back shroud of the fryer.
2. Using spindle lube, part number 12124, place a small amount of lube on both top and bottom rollers. Make sure to lube both left and right rollers.
3. Wipe Nylatrons to remove food soil, grease, and degreaser residue.

**3-14.  
PREVENTIVE  
MAINTENANCE**

**Cleaning Blower Wheel - Annually**

The blower wheel must be cleaned annually to ensure the unit operates efficiently and without failures.

1. Make sure unit is off, and close and lock the lid.



**Lid should be in locked down position. Failure to do so could result in personal injury.**



2. Remove the back shroud of the unit.
3. Remove the hose from the blower housing.



**On the newer fryers, the blower tube will slide out of the bracket instead of bolted. See photo below.**



4. Clean the fins of the blower wheel, using a brush or straight blade screwdriver. Make sure the fins are clean of any debris.



**Depending on the breading location and conditions within the kitchen area, cleaning the blower wheel may need to be done more frequently.**



**3-14.  
PREVENTIVE  
MAINTENANCE  
(CONT.)**



Figure 1



Figure 2

**Inspect Counter-weight Cables-Annually**

Henny Penny 8 head fryers use two cables in the counter-weight mechanism that helps in the raising and lowering of the lid. Cables should be visually inspected yearly, either as part of a planned maintenance program or during a routine service call. Cables more than 10 years old should be replaced regardless of inspection results.

**NOTICE**

If lid becomes difficult to operate, stop using the fryer and call for service. Cables need replaced.

1. Using a Phillip's-head screwdriver, remove top screw, but just loosen the lower screw on each side of the fryer, shown in Figure 1.
2. Lift out on the top of the rear cover and then lift up on it to clear loosen screw, circled in Figure 2.

**NOTICE**

Model 390 SN: AP802028  
& Below

Models 390 SN  
AP082029 & Above



**3-14.  
PREVENTIVE  
MAINTENANCE  
(CONT.)**

3. Inspect the counter-weight cables. If cables have cracks in the jacket, missing pieces in the jacket, or other obvious signs of wear, call for service to have both cables replaced.

**NOT OK - REPLACE**  
**Cracks in jacket and obvious signs of wear.**

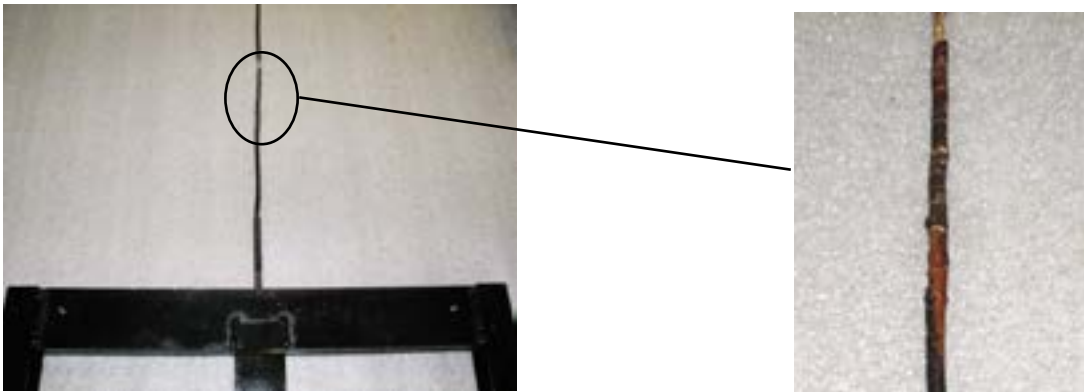

**OK**  
**No signs of cracking or wear.**

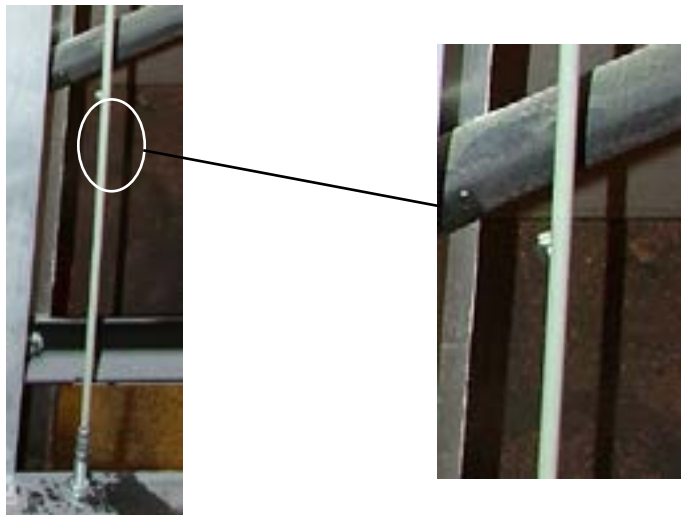



**3-15.  
PROGRAMMING**

1. Press and hold the FUNCTION button for two seconds. “REG PROGRAM” shows in the display, followed by “CODE”.
2. Press the code 1,2,3, “SELECT PRODUCT” scrolls across the display.

**NOTICE**

If no buttons are pressed, within approximately 1 minute while in the Program Mode, the controls will revert back to the Cook Mode.

3. Press the appropriate product button, (1-0), to identify what product you want to program.
4. “INT1” and “TIME” flashes on the left side of the display. The right side will show the starting time of the Cook Cycle and can be changed by pressing the appropriate numbers. Ex: Press 1,0,0,0 and 10:00 flashes on the right side of the display, setting the start time at 10 minutes.
5. After the time is set, press and release the FUNCTION button and “INT1” and “TEMP” flashes on the left side of the display. The right side will show the starting temperature and can be changed by pressing the appropriate numbers. Ex: Press 2,5,0 and “250° F” will show on the right side of the display, setting the start temperature at 250° Fahrenheit.
6. After the temperature is set, press and release the FUNCTION button and “INT1”, “LOAD”, and “COMP.” flashes on the left side of the display. The factory preset load compensation value shows in the right side of the display.
7. After the load compensation, press and release the FUNCTION button. “PROP” and “CONTROL” shows on the left side of the display and the factory preset proportional control temperature shows on the right side of the display.

**3-15.  
PROGRAMMING  
(CONT.)**

8. After the proportional control, press and release the FUNCTION button. "ALM 1" and "TIME" flashes in the left side of the display, and the first alarm time shows on the right side of the display. To change the time the alarm sounds, press the appropriate product buttons to set the time. Ex: Press 1,0,0,0. 10:00 flashes on the right side of the display, which means when the timer counts down to 10 minutes, an alarm sounds.
9. After alarm is set, press and release the FUNCTION button. "ALM 1", "SELF-", and "CANCEL" flashes in the left side of the display and "YES" or "NO" shows on the right side of the display. The yes and no can be toggled by pressing any of the product buttons, (1-0). "YES" means the alarm tone automatically stops after several beeps. "NO" means some one must manually press the appropriate product button to stop the alarm tone.
10. Repeat steps 9 and 10 for alarms 2 and 3.
11. After alarm 3 is set, press and release the FUNCTION button. "FILTER" and "CYCLES" show on the left side of the display and the Filter Cycle value is on the right side of the display. The value is the number of Cook Cycles that must completed before the control signals the operator that the shortening needs filtered.
12. After the filter value is set, press and release the SELECT FUNCTION button. "EOC" and "EXIT" flashes on the left side of the display and "COOL" shows on the right side of the display. The end-of-cycle, (EOC), exit point can be set to COOL, SETP, or FITR, by pressing any of the product buttons (EOC). At the end of a Cook Cycle the controls can be set to return to Cool Mode, the setpoint temperature, or to signal the operator to filter the shortening.
13. After the end-of-cycle point is set, press and release the FUNCTION button. "HEAD" flashes on the left side of the display and a number shows on the right side of the display. The number on the right, is the number of head of chicken to be cooked at one time, when that product button is pressed. The number can be changed by pressing the appropriate product button. The control can then accumulate the head count (usage) of that product, based on counting the number of Cook Cycles.

**3-15.  
PROGRAMMING  
(CONT.)**

14. To program second interval, press and release the SCAN button while in the Time Mode of the first mode. "INT2" and "TIME" will flash on the left side of the display. Then follow the steps above, starting with step 4.

**NOTICE**

Another product can be programmed while in the program mode by following these procedures:

Press and hold the SCAN button at any time while in the Program Mode and the display will scroll "SELECT PRODUCT". Then press any of the product buttons, (1-0), and now that product can be programmed.

**3-16.  
SPECIAL PROGRAM  
MODE**

**Review Usage**

1. Press and hold the FUNCTION button for two seconds until "REG PROGRAM" shows in the display. As soon as "REG PROGRAM" shows in the display, press and release the FUNCTION button 1 time until "REVIEW USE" shows in the display.
2. "DAILY" shows in the display. Press any of the product buttons to view the usage of that product. Press and hold the FUNCTION button to exit Special Program mode.

**Reset Usage**

1. Press and hold the FUNCTION button for two seconds until "REG PROGRAM" shows in the display. As soon as "REG PROGRAM" shows in the display, press and release the FUNCTION button 2 times until "RESET USE" shows in display.
2. When "CODE" shows in the display, press 1-3-5. "DAILY" will show in the display, and press any of the Product buttons to reset them to 0.

**3-16.  
SPECIAL PROGRAM  
MODE  
(CONT.)**

**Factory Presets (F/C, Gas/Electric, Speaker Volume, Speaker Frequency, Codes, Initialize System)**

1. Press and hold the FUNCTION button for two seconds until “REG PROGRAM” shows in the display. As soon as “REG PROGRAM” shows in the display, press and release the FUNCTION button 3 times until “FAC PRESET” shows in the display.
2. When “CODE” shows on the display, enter 2957. “DEG” and “MODE” flashes in the display. Press any of the product buttons to toggle from °F to °C, and vice versa.
3. Press and release the FUNCTION button and “TYPE” and “FRYR” flashes in the display. Press any of the product buttons to toggle from “GAS” to “ELEC”, or vice versa.
4. Press and release the FUNCTION button twice, and “SPKR” and “VOL” flashes in the display. The volume can be changed from 01 to 10, 10 being the loudest.
5. Press and release the FUNCTION button 3 times, and “SPKR” and “FREQ” will flash in the display. The frequency can be set from 100 to 2000.
6. Press and release the FUNCTION button 10 times, and “INITIALIZE SYSTEM” scrolls across the display. Press and hold any of the product buttons and the display will count down from 5. Once the display counts down, release the product button, and the control will set factory preset parameters into the controls.

**NOTICE**

Before attempting to change the other modes in the Factory Preset Mode, please call the Henny Penny Technical Service Department at 1-800-417-8405, or 1-937-456-8405.

**3-16.  
SPECIAL PROGRAM  
MODE  
(CONT.)**

**Tech I/O Mode**

1. Press and hold the FUNCTION button for two seconds until “REG PROGRAM” shows in the display. As soon as “REG PROGRAM” shows in the display, press and release the FUNCTION button 4 times until “TECH I-O” shows in the display.
2. When “CODE” shows in the display, press 2-4-6 (1-7-7-6 for CE units). “HEAT”, and “PUMP” shows alternately in the display. Also, the LEDs over 1 and 3 flashes alternately.
3. To test the heat circuit, press and hold the 1 button.
4. To test the pump system, press and hold the 3 button.

**NOTICE**

To test the heat output on CE units, the blower and modules must first be turned on.

**Appliance Test**

Press and hold the FUNCTION button for two seconds until “REG PROGRAM” shows in the display. As soon as “REG PROGRAM” shows in the display, press and release the FUNCTION button 5 times until “APPL TEST” shows in the display.

With the power switch on, the display will show “CURR=”, along with the time it took the unit to heat from 250° to 300° F (121° to 149° C) . This is normally recorded from the initial heat up in the morning.

**3-16.  
SPECIAL PROGRAM  
MODE  
(CONT.)**

**Heat Control**

1. Press and hold the FUNCTION button for two seconds until “REG PROGRAM” shows in the display. As soon as “REG PROGRAM” shows in the display, press and release the FUNCTION button 6 times until “HEAT CNTRL” shows in the display.
2. When “CODE” shows in the display, press 1-2-3-4. “MELT”, “EXIT”, and “TEMP” flashes in the display, along with the shortening temperature at which the unit will exit the melt cycle. This should be set at 180° F (82° C), and should not be changed until the factory is consulted.
3. Press and release the FUNCTION button and ”MELT”, “CYCLE”, and “100s” shows alternately in the display, along with the period (pulse) length of 4000. This should not be changed until the factory is consulted.
4. Press and release the FUNCTION button twice and “MELT”, “ON-”, “TIME”, and “100s”, shows alternately in the display, along with the length of time the heat is on. This should be set at 1700, and should not be changed until the factory is consulted.
5. Press and release the FUNCTION button three times and “COOL”, “SET-”, and “POINT” shows alternately in the display, along with the temperature at which the control exits the melt cycle. This is set at 250° F (121° C), and should not be changed until the factory is consulted.
6. Press and release the FUNCTION button four times and “AUTO”, and “IDLE” shows alternately in the display, along with “OFF”. This should not be changed until the factory is consulted.
7. Press and release the FUNCITON button five times and “AUTO”, “IDLE”, and “MMSS” shows alternately in the display, along with “0:00”. This should not be changed until the factory is consulted.
8. The last 3 functions in the Heat Control Mode are used by the factory only, and should not be changed.

## SECTION 4: TROUBLESHOOTING

### 4-1. TROUBLESHOOTING GUIDE

Problem	Cause	Correction
Power switch on but fryer completely inoperative	<ul style="list-style-type: none"> <li>Open circuit</li> </ul>	<ul style="list-style-type: none"> <li>Fryer plugged in</li> <li>Check breaker or fuse at wall</li> </ul>
Shortening not heating	<ul style="list-style-type: none"> <li>Gas valve knob turned to the OFF position</li> <li>Drain valve open</li> <li>High temperature limit tripped</li> </ul>	<ul style="list-style-type: none"> <li>Make sure gas control valve knob is turned to the ON position</li> <li>Close drain valve</li> <li>Reset high temperature limit; see Operating Controls Section</li> </ul>
Foaming or boiling over	<ul style="list-style-type: none"> <li>See Boil-Over chart on fryer and beginning of Operation Section in this manual</li> </ul>	<ul style="list-style-type: none"> <li>Follow boil-over procedures from chart.</li> </ul>
Shortening not draining	<ul style="list-style-type: none"> <li>Drain valve clogged</li> </ul>	<ul style="list-style-type: none"> <li>Push cleaning rod through open drain valve.</li> </ul>
Filter motor won't run	<ul style="list-style-type: none"> <li>Motor overheated</li> </ul>	<ul style="list-style-type: none"> <li>Reset motor; see Filter Motor Protector Manual Reset Section</li> </ul>
Product Color Not Correct: A. Too Dark	<ul style="list-style-type: none"> <li>Temperature too high</li> <li>Breading to far in advance</li> </ul>	<ul style="list-style-type: none"> <li>Check temperature setting in the Program Mode</li> <li>Bread product closer to frying period</li> </ul>
B. Too Light	<ul style="list-style-type: none"> <li>Temperature too low</li> <li>Fryer incorrect preheat</li> <li>Wrong product button pressed</li> </ul>	<ul style="list-style-type: none"> <li>Check temperature setting in the Program Mode</li> <li>Allow proper preheat time</li> <li>Be sure to press the correct product to be cooked</li> </ul>
C. Product Greasy	<ul style="list-style-type: none"> <li>Shortening old</li> <li>Temperature too low</li> <li>Frypot overloaded</li> <li>Product not removed from frypot immediately after end of cycle</li> </ul>	<ul style="list-style-type: none"> <li>Replace shortening</li> <li>Check temperature setting in the Program Mode</li> <li>Reduce cooking load</li> <li>Remove product from frypot promptly</li> </ul>

### NOTICE

More detailed troubleshooting information is available in the Technical Manual, available at [www.hennypenny.com](http://www.hennypenny.com), or 1-800-417-8405 or 1-937-456-8405

## 4-2. ERROR CODES

In the event of a control system failure, the digital display shows an error message. These messages are coded: “E-4”, “E-5”, “E-6”, “E-32”, “E-41” and “E-71”. A constant tone is heard when an error code is displayed, and to silence this tone, press any of the product buttons.

Display	Cause	Panel Board Correction
“E-4”	Control board overheating	Turn switch to OFF position, then turn switch back to ON; if display still shows “E-4”, the board is getting too hot; check for signs of overheating behind the control panel; once panel cools down the controls should return to normal; if “E-4” persists, have control panel replaced
“E-5”	Shortening overheating	Turn switch to OFF position, then back to ON; if display shows “E-5”, the heating circuits and temperature probe should be checked; once the unit cools down, the controls should return to normal; if “E-5” persists, have control panel replaced
“E-6”	Temperature probe failure	Turn switch to OFF position, then back to ON; if the display shows “E-6”, the temperature probe should be checked; once the probe is repaired, or replaced, the controls should return to normal; if “E-6” persists, have control panel replaced
“E-41”	Programming failure	Turn switch to OFF position, then back to ON; if display shows “E-41”, the control should be re-initialized (See Programming Section) if the error code persists, have control panel replaced
“E-71”	Pump motor relay failure or wiring problem	Pump motor relay failure or Replace relay if contacts are stuck closed; check wiring on POWER/PUMP switch, or at wall receptacle; L1 and N may be reversed
“E32, FAN FAIL ERROR, CHECK BLOWER, CLEAN DILUTIONBOX, CALL HENNY PENNY SERVICE”	Air pressure switch open; clogged dilution box or faulty blower; open drain switch; open high limit	Clean dilution box or replace blower if necessary; have drain switch checked; reset high limit or have high limit checked



**4-2.  
ERROR CODES  
(CONT.)**

**CE Only - Along with the error codes from page 4-2, CE units have the following self-diagnostic error codes:**

<b>Display</b>	<b>Cause</b>	<b>Panel Board Correction</b>
"E-10"	High limit	Reset the high limit by manually pushing up on the red reset button; if the high limit does not reset, the high limit must be replaced
"E-15"	Drain switch	Close the drain, using the drain valve handle; if display still shows "E-15", have the drain microswitch checked
"E-20A"	Air pressure switch failure	Press the timer button to try the ignition process again, and if "E-20A" persists, call Henny Penny's Service (stuck closed) Department
"E-20B"	<u>Draft fan or air pressure switch failure (stuck open)</u>	<u>Press the timer button to try the ignition process again, and if "E-20B" persists, call Henny Penny's Service Department</u>
"E-20C"	<u>Left gas module failure</u>	<u>Press the timer button to try the ignition process again, and if "E-20C" persists, call Henny Penny's Service Department</u>
"E-20D"	<u>Right module failure</u>	<u>Press the timer button to try the ignition process again, and if "E-20D" persists, call Henny Penny's Service Department</u>
"E-20E"	<u>Both modules failure</u>	<u>Press the timer button to try the ignition process again, and if "E-20E" persists, call Henny Penny's Service Department</u>
"E-20F"	<u>Left module no flame sense</u>	<u>Press the timer button to try the ignition process again, and if "E-20F" persists, call Henny Penny's Service Department</u>
"E-20G"	<u>Right module no flame sense</u>	<u>Press the timer button to try the ignition process again, and if "E-20G" persists, call Henny Penny's Service Department</u>
"E-20H"	<u>Both modules no flame sense</u>	<u>Press the timer button to try the ignition process again, and if "E-20H" persists, call Henny Penny's Service Department</u>



**Henny Penny Corporation  
P.O.Box 60  
Eaton, OH 45320**

**1-937-456-8400  
1-937-456-8402 Fax**

**Toll free in USA  
1-800-417-8417  
1-800-417-8434 Fax**

**[www.hennypenny.com](http://www.hennypenny.com)**